

SFB150-2PT-KIT



Kit with 2x Stryder 150 Watt Fresnel with Hard Case



What's Included

- 2 x 4" Fresnel Light Fixture
- 2 x Controller Box w/ V-Mount Plate
- 2 x Cable From Controller to Fixture (6ft)
- 2 x Barn Doors
- 2 x Yoke w/ Baby 5/8" Adapter
- 2 x Power Adapter
- 2 x Light Stand
- 1 x Light Stand Bag
- 1 x Rolling Hard Case



Getting Started

Thank you for buying the SFB150 Fresnel Light from ikan. Please carefully read the instructions and guide before operating the products. The guide includes product usage and maintenance. When you operate the product, please make sure that you have read the instructions carefully.

All the content of the manual is based on up-to-date information; technical data subject to change without notice.

Overview

Absolute lighting control is right at your fingertips with this Stryder Fanless 150 watt LED Fresnel Light with DMX. The impressive daylight LED features a 4" Fresnel lens with a spot to flood beam range of 30 to 65°. Toss in the ability to accurately shape light with removable barn doors, dimming capabilities between 0-100% (controlled in increments 5), and its ability to use traditional gel rings, mean that this workhorse of a light will undoubtedly become a staple in your kit.

Structure

- A. LCD Display
- B. Color Temperature/
Confirmation Knob
- C. DMX Channel Adjustment
- D. Brightness Knob
- E. DMX Input
- F. DMX Output
- G. XLR Power Port
- H. Yoke Adjustment Knob
- J. Barn Door Locking Pin
- K. Power Input (from control panel)
- L. Focusing Knob
- M. Power Switch
- N. Power Out (to light fixture)
- P. V-Mount Battery Plate

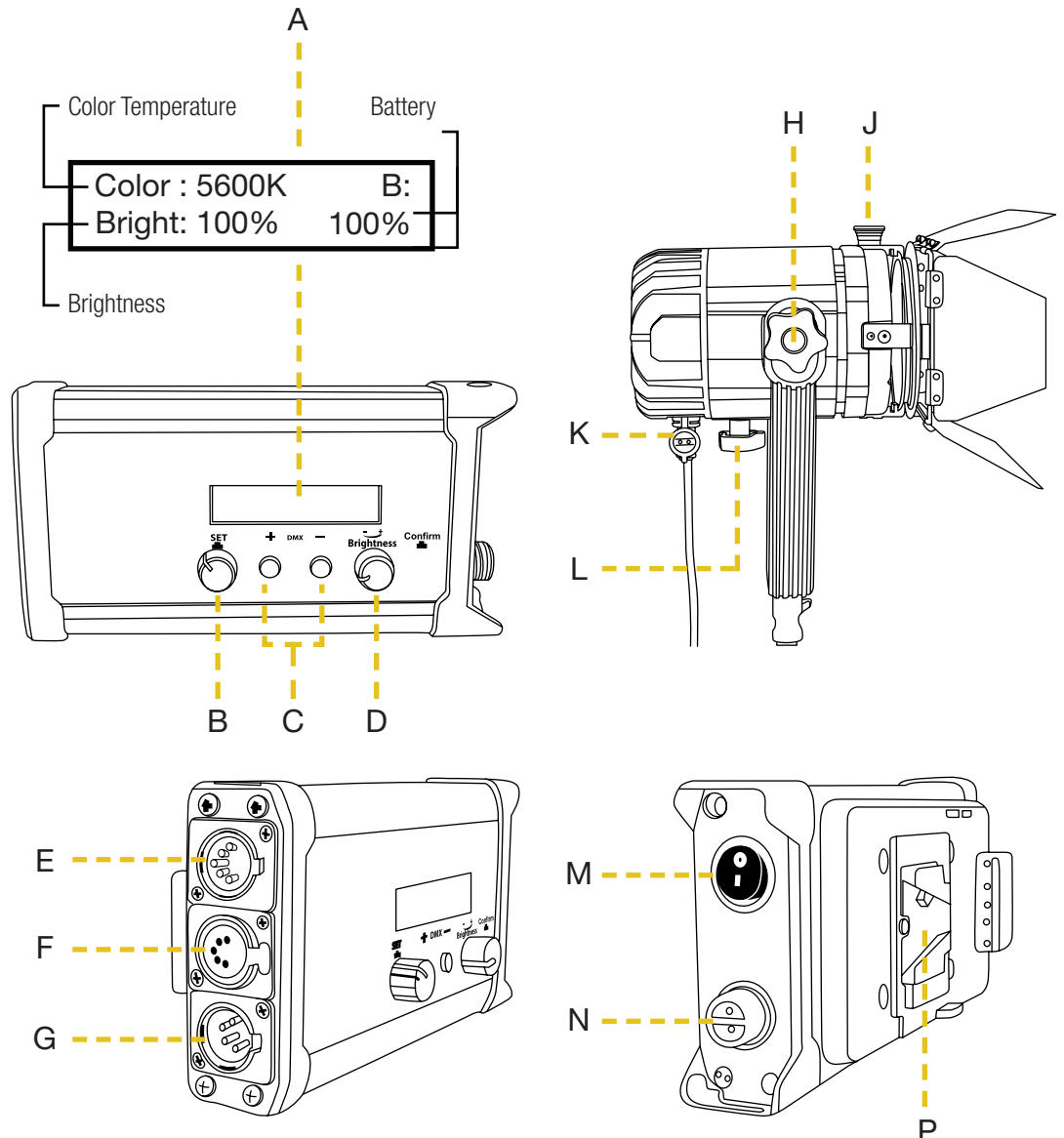

Notice & Maintenance

- Products must be placed on a stable, dry, flat surface. Avoid exposure to sunlight and operating in an environment with high humidity or explosive gas.
- Don't cover the fan vent. It will shorten the working life of the fixture.
- Don't knock or shake the lighting equipment during the operation.
- If the SFB150 isn't working normally, please contact the Ikan repair department. Please don't disassemble/re-assemble by yourself.
- Please place the SFB150 in a cool and dry place when you don't use it for an extended period of time.

Specifications

Beam Angle	30 - 65 degrees
Build Material	Aluminum
Control	Local Knob Control and DMX In/Out
Cooling System	Fanless Passive Cooling
Dimming	Flicker Free Dimming, Onboard Dimming Knob 10%-100% (minimal color shift)
Focusing	Push Focus from 30 - 65
Head Type	3200K - 5600K
Lens	4" Acrylic Fresnel
Light Source	1 x 150 watt LED Bi-Color
Power Consumption	98W
Power Supply	110-240VAC; Output: 12V@12.5A
Yoke	Baby 5/8"

Optional Accessories

Some other products that work well with the Stryder SFB150 available from Ikan include:

HD-STND-V2	Heavy Duty Light Stand
KCP-703	Stage Clamp w/ 16mm Stud
SW-04	Safety Wire

Learn More

More dynamic information at official website: www.ikancorp.com

Support

Contact email: support@ikancorp.com

CONDITIONS OF WARRANTY SERVICE

- Free service for one year from the day of purchase if the problem is caused by manufacturing errors.
- The components and maintenance service fee will be charged if the warranty period is expired.

Free Service will not be Provided in the Following Situations:

(Even if the product is still within the warranty period.)

- Damage caused by abuse or misuse, dismantling, or changes to the product not made by the company.
- Damage caused by natural disaster, abnormal voltage, and environmental factors, etc.

©2020 Ikan International. All rights reserved.

