



The magic life in the image world

E-IMAGE

GA102 100mm Aluminum Video Tripod

The GA102 two stage aluminum tripod supports a payload weighing up to 132 lbs. It is made of lightweight aluminum, has a 100mm bowl, and the legs are a twin tube design with two stages. The tripod can be adjusted to a maximum height of 63" and a minimum height of 18" with a folded length of 29". The mono-lock feature allows for quick height adjustments of both stages with one twist. An adjustable floor spreader provides extra security and stability.



 100mm	 160.0cm 63.0in	 47.0cm 18.5in	 74.0cm 29.1in
 60.0kg 132.0lbs	 5.1kg 11.2lbs	 Aluminum	 3

2-stages With Mono-lock Patent Design

Mono-lock design allows you to lock and unlock the three sections of each leg using only one locking lever quicker than normal.



Mono-Lock Design

 One lock for one section

 One lock for one section

FEATURES



100mm Bowl Size

Compatible with all professional 100mm half-ball video heads.



Extendable Ground Spreader

Extendable spreader is designed to offer added stability to the tripod.



Removable Rubber Feet

Removable feet attach to the spiked feet for working on delicate or hard surfaces.

GH20 100mm Fluid Head



-  100mm
-  20.0kg / 44.0lbs
-  0-8

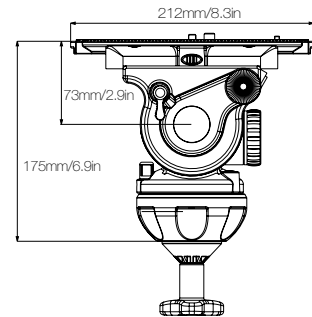
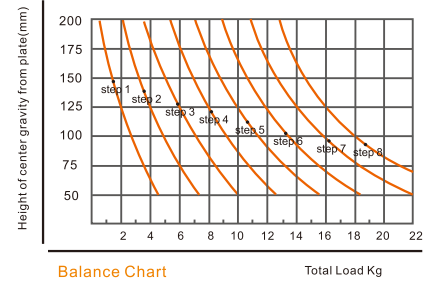

FEATURES



Fixed drag of pan & tilt



Longer sliding plate











Leveling bubble



8 plus 0 steps of counterbalance

SPECIFICATIONS

Model	GH20
 Payload Range	20.0kg / 44.0lbs
 Counterbalance Range	0-8
 Grades Of Pan Drag	Fixed
 Grades Of Tilt Drag	Fixed
 Tilt Range	-60°/+90°
 Temperature Range	-30°C~+60°C
 Bowl Size	100mm
 Net Weight	3.5kg / 7.7lbs



The magic life in the image world

E-IMAGE

VIDEO TRIPOD



Model	GA101
	100mm
	140.5cm / 55.3in
	63.5cm / 25.0in
	85.0cm / 25.0in
	60.0kg / 132.0lbs
	4.5kg / 9.9lbs
	Aluminum
	2

VIDEO TRIPOD SYSTEM



Model	EG20A (GH20+GA101)
	20.0kg / 44.0lbs
	156.0cm / 61.4in
	79.0cm / 31.1in
	100.5cm / 39.6in
	8.4kg / 18.5lbs
	100mm
Packing	T30





The magic life in the image world

E-IMAGE

EI-7004B Video Dolly

Super sturdy, designed for heavy duty systems. The 100mm/4 inch wheels can be individually braked.



FEATURES

