

# Flyweight Camcorder

## Flyweight QUICKSTART GUIDE

---

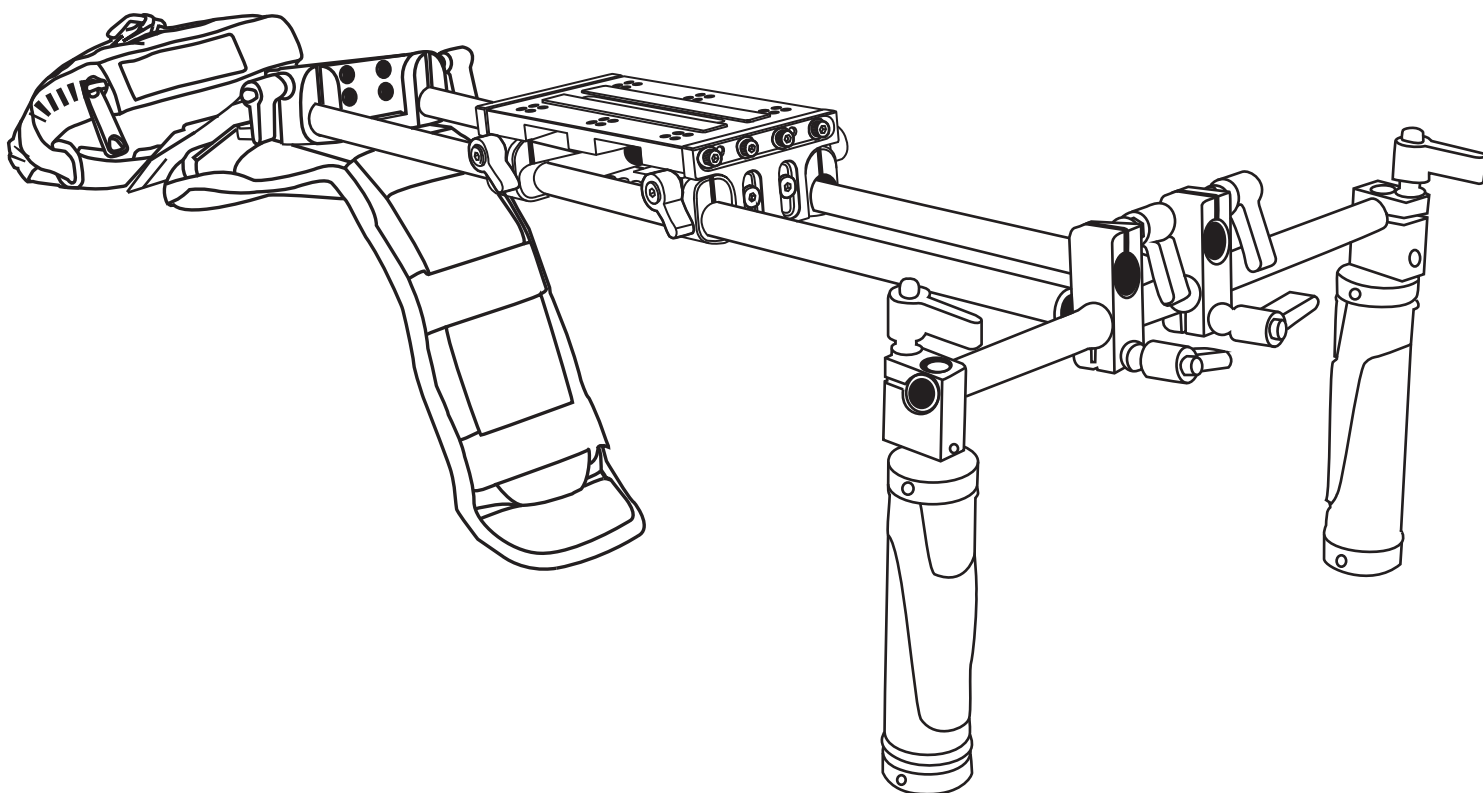

# Flyweight Camcorder

## Flyweight QUICKSTART GUIDE

### What's included

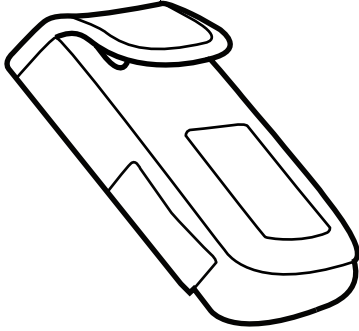

1 x Weightbag (ELE-WB)

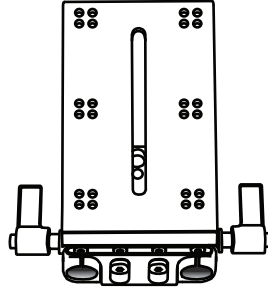

1 x Baseplate (ELE-SBP)

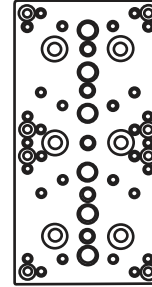

1 x Double Cheeseplate (ELE-DBLPT)

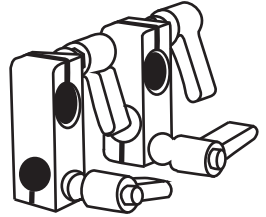

1 x Crossblocks (ELE-CB-19)

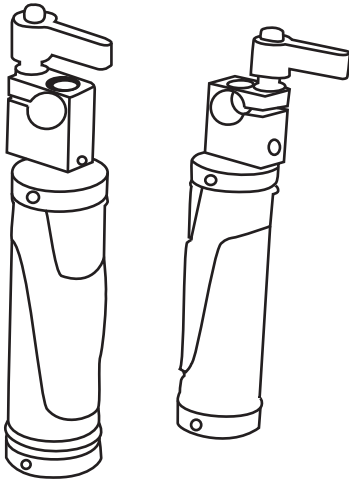

2 x Grip Handles

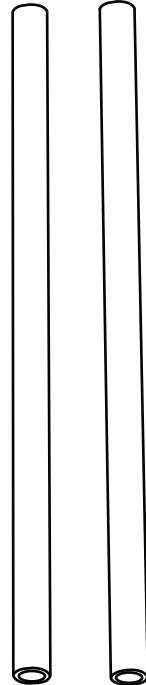

2 x 18' Rods (ELE-15R18)

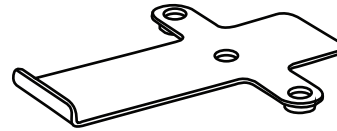

1 x T-Plate



1 x DRS-01



1 x 18' Rod (ELE-15R12)

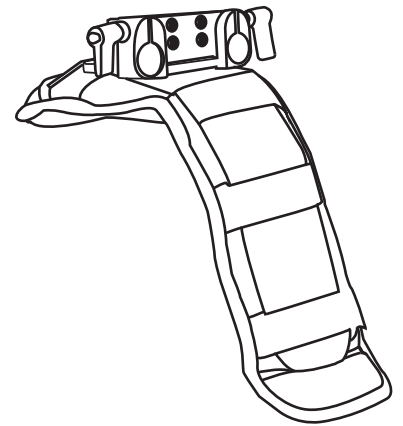

1 x Shoulder Mount



2 x Thumbscrews



4 x (1/4 -20 x 3/4) Socket Head Screw

# Flyweight Camcorder

## Flyweight QUICKSTART GUIDE

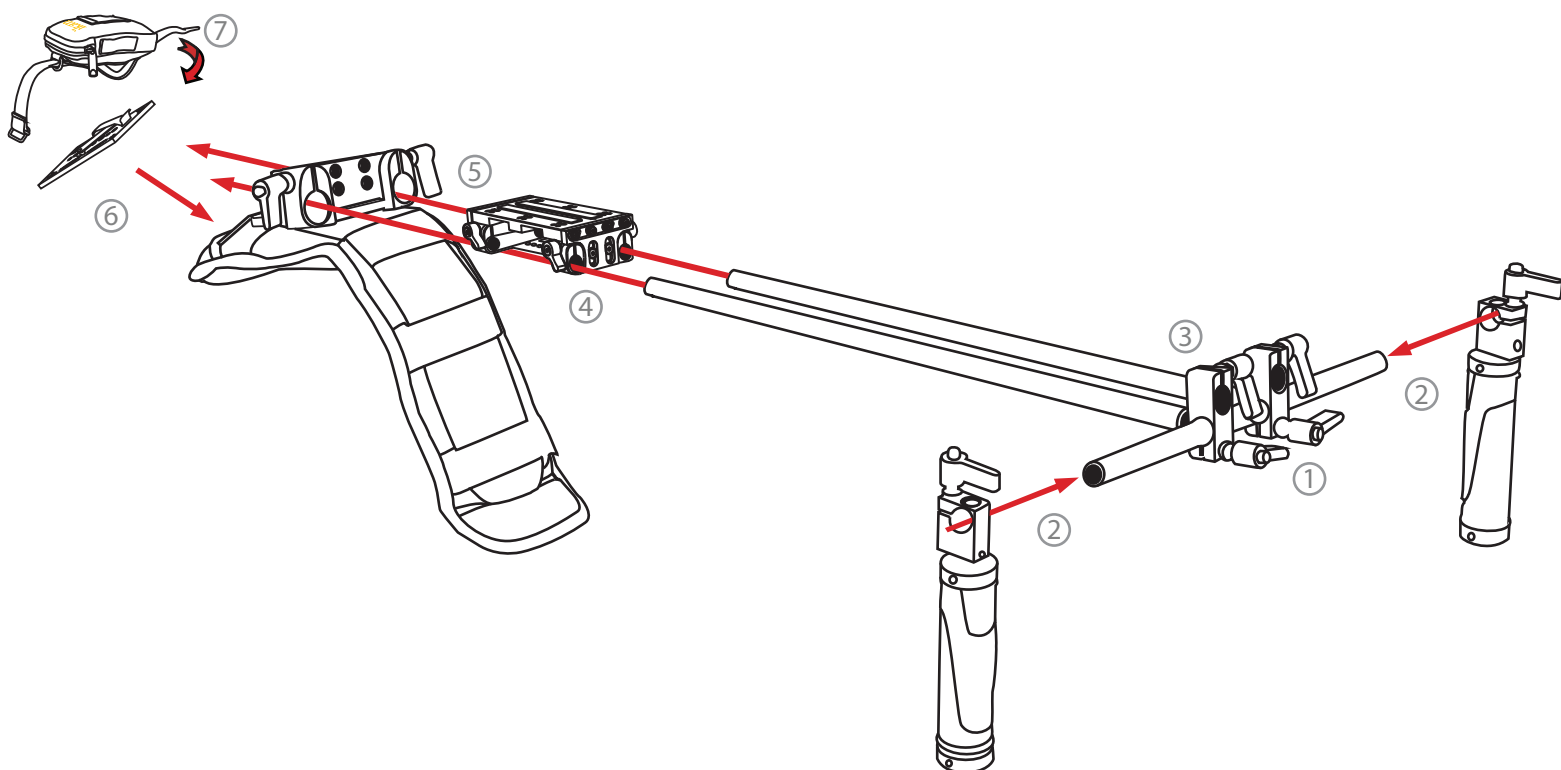

# Flyweight Camcorder

## Flyweight QUICKSTART GUIDE

### ADJUSTMENT POINTS

Numerous Adjustment Points allow for precise positioning modifications to the Small Base Plate component of your Flyweight Camcorder Kit.

Loosen Thumb Screws to move 18" Rods forward/backwards.

Loosen front Hex Screws to make vertical/horizontal adjustments.

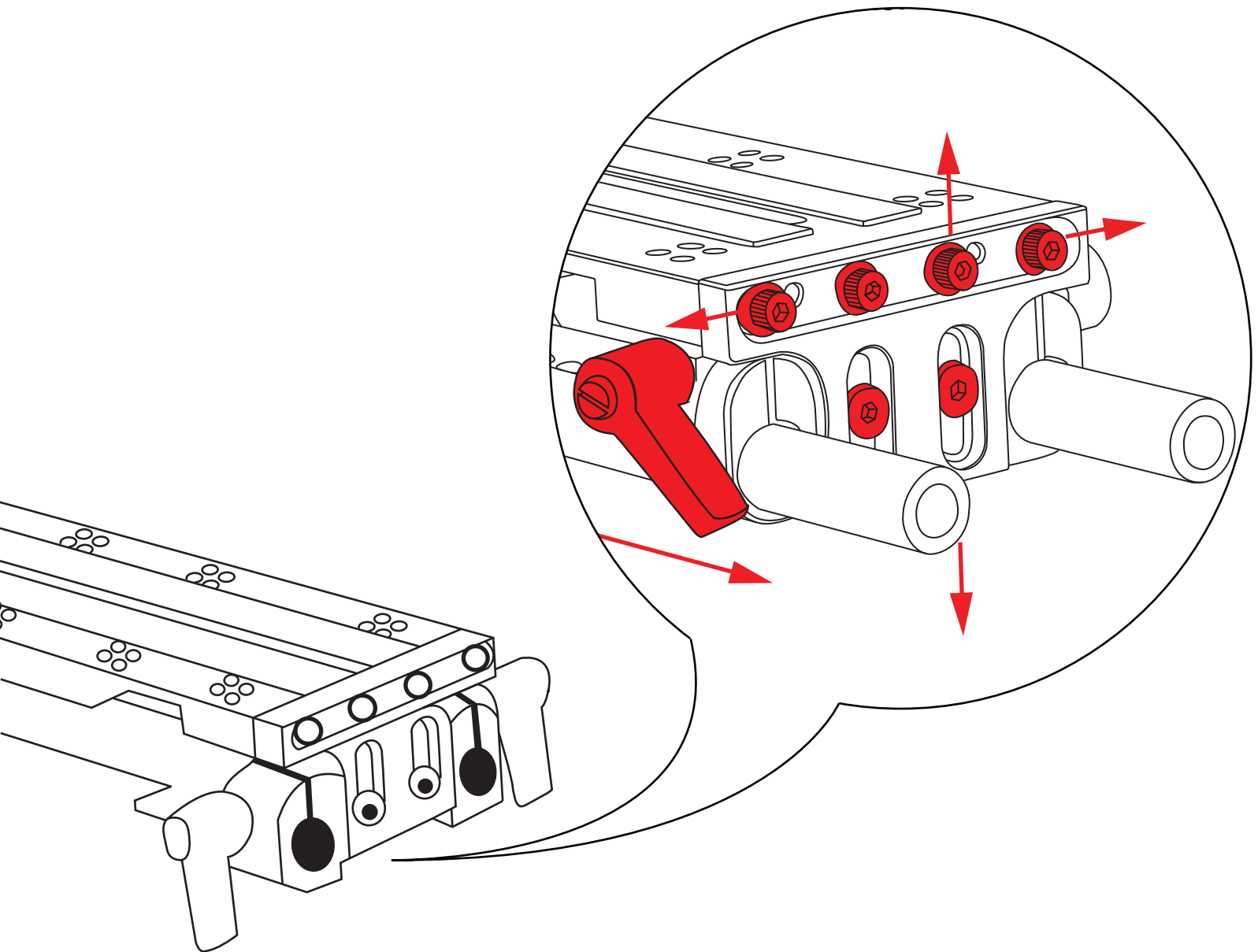

# Flyweight Camcorder

## Flyweight QUICKSTART GUIDE

### ATTACHING DOUBLE CHEESEPLATE

To attach the Double Cheeseplate (ELE-DBLPT) onto the Shoulder Mount, lift up the strap and screw two Socket Head Screws through the indicated holes of the Double Cheeseplate and Shoulder Mount. Once in place, return the strap back to its original position.

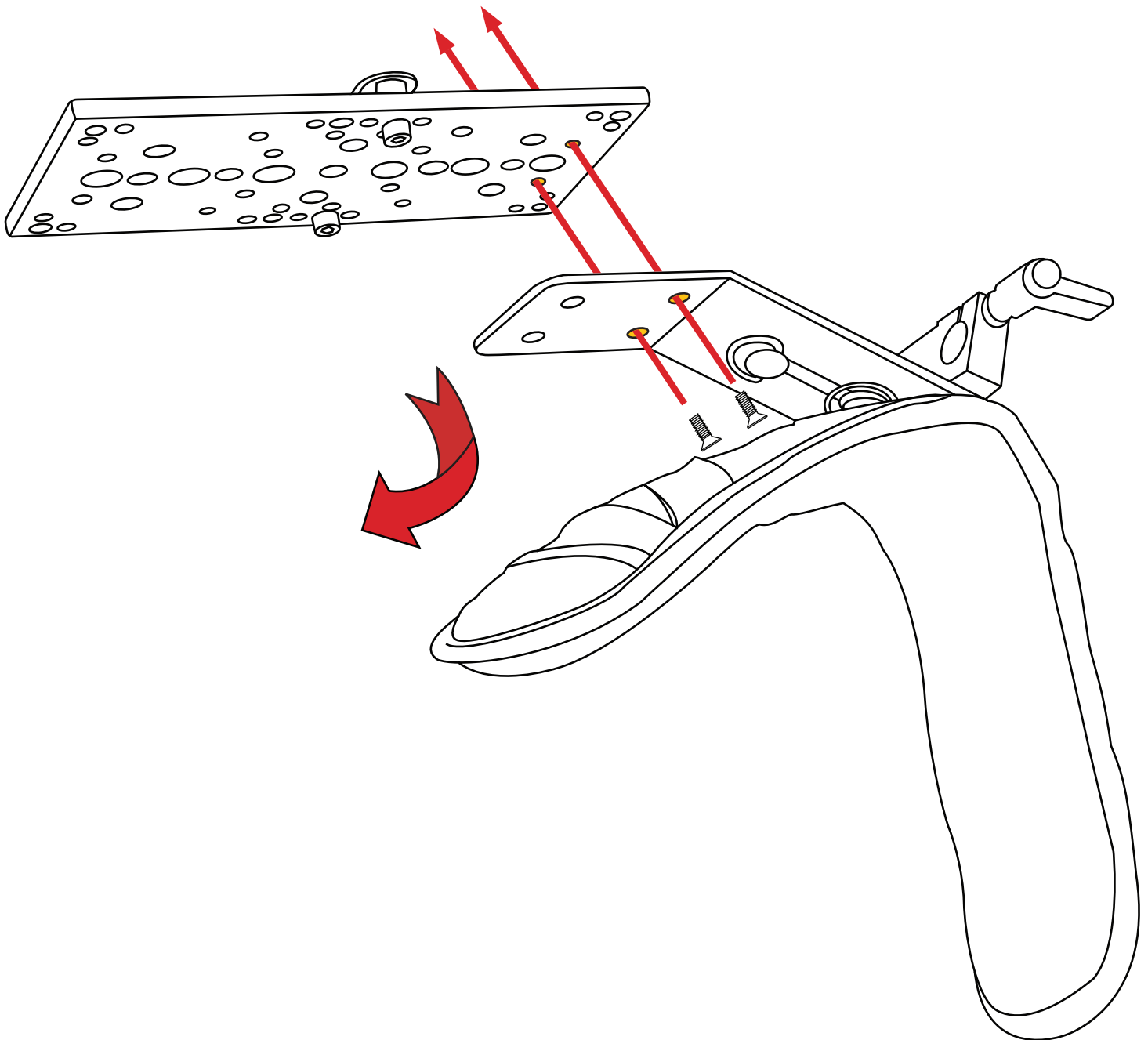

# Flyweight Camcorder

## Flyweight QUICKSTART GUIDE

### ATTACHING BELTCLIP

To attach the T-Plate onto the Double Cheeseplate (ELE-DBLPT), screw two Socket Head Screws through the T-Plate into the central holes of the Double Cheeseplate.

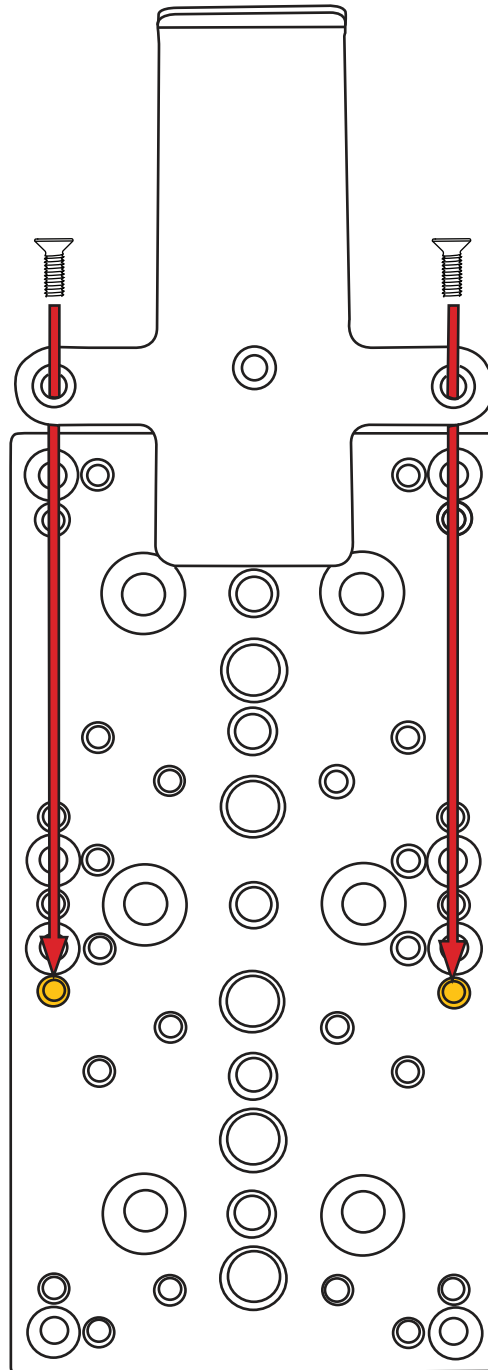

# Flyweight Camcorder

## Flyweight QUICKSTART GUIDE

### SECURING WEIGHT BAG

To secure the weight bag (ELE-WB) onto the Flyweight Camcorder, follow these simple steps. (1) First, slide the strap through the slots around the weight bag. (2) After the strap is secured, hook the strap onto the Double Cheeseplate (ELE-DBLPT) with the attached T-Plate.

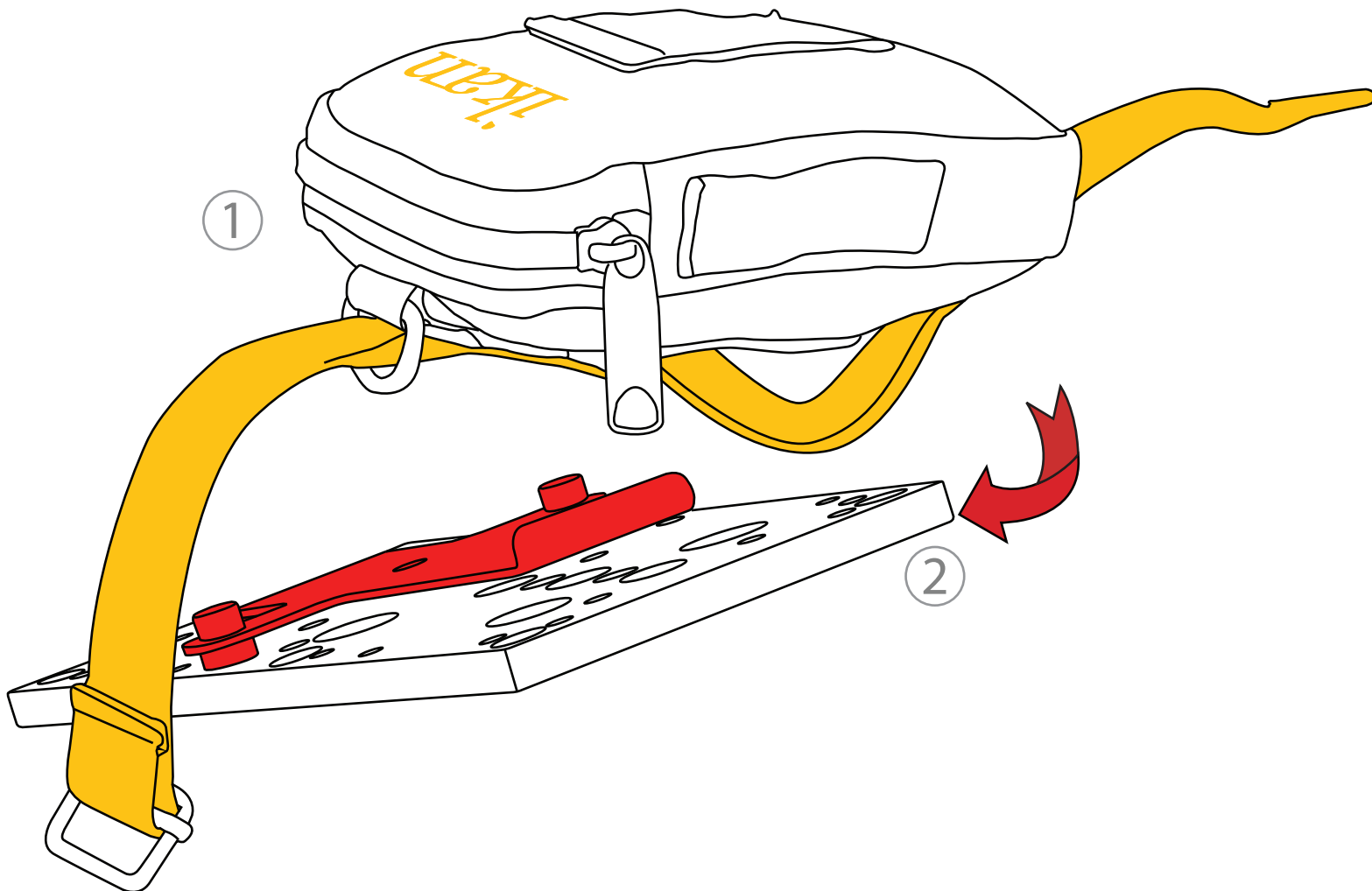

### WEIGHTS NOT INCLUDED

Please be aware that your weight bag does not come with its own weights.

# Flyweight Camcorder

## Flyweight QUICKSTART GUIDE

### BASE PLATE ATTACHMENT POINTS

There are a total of four threaded attachment points for your base plate; five 3/8-16 and four 1/4-20 threaded holes for you to choose from. Simply tighten the screw from your base plate into the appropriate hole for easy mounting and unmounting from your tripod's quick release.

#### Screw thread sizes

 3/8-16

 1/4-20

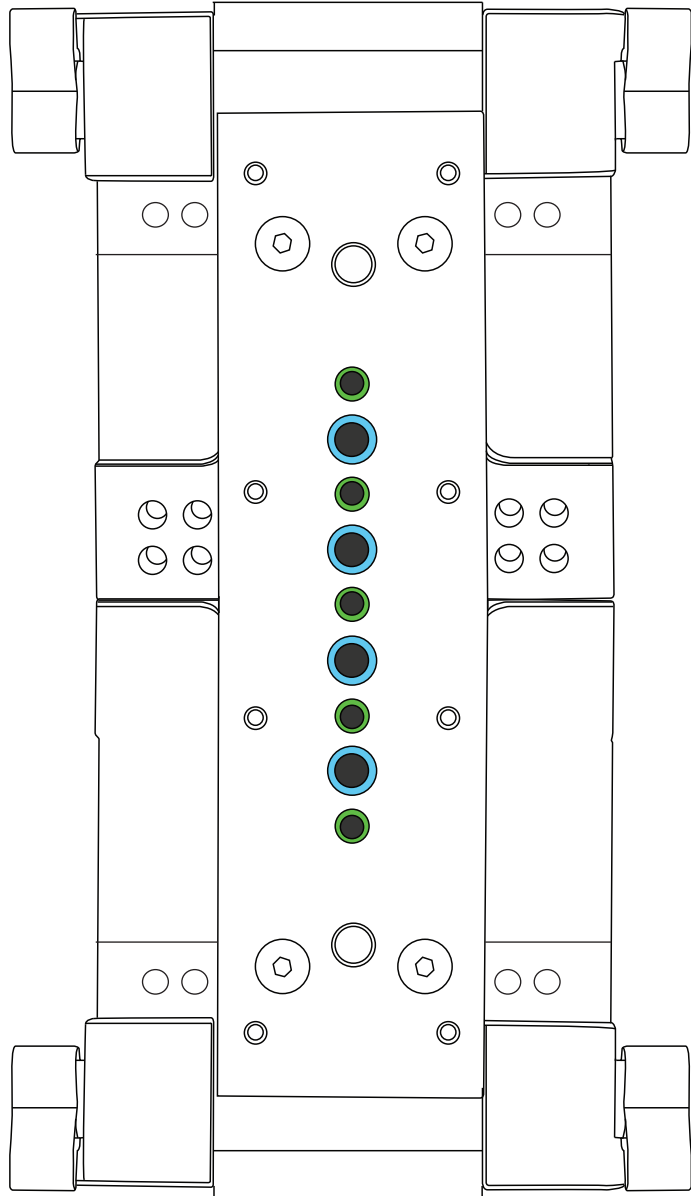

\*Bottom View

ikan

[www.ikancorp.com](http://www.ikancorp.com)

713-272-8822



# Flyweight Camcorder

## Flyweight QUICKSTART GUIDE

### MOUNTING YOUR CAMERA

Loosen the thumb screw and slide out one of the 12" rods, in order to gain access to easily fit your hand underneath the top portion of the small base plate. Next, take the D-Ring and slide it through the opening. Align the 1/4-20 threaded hole on the bottom of your camera with the D-Ring and tighten until your camera is secure. Finally, slide the 12" rod back to its original position and tighten the thumb screw.

